



FVN62-361236-VSL

TORINO

INSTALLATION GUIDE

CONTENTS:

Cabinet	(FCB62-361236)	PAGE 3
Sink	(FVS6217)	PAGE 4
Mirror	(FMR6236)	PAGE 2
Countertop	(FCT6236)	PAGE 4

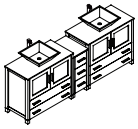

FVN62-361236-VSL TORINO INSTALLATION GUIDE



Mirror 2PCS

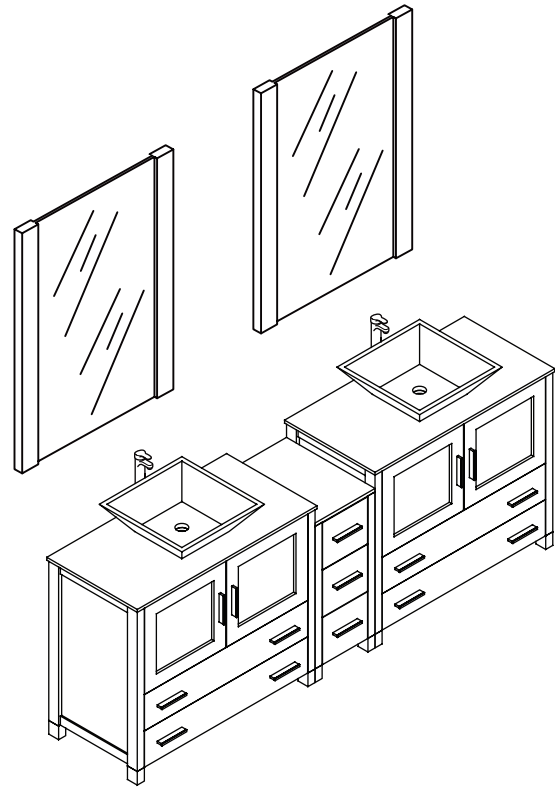
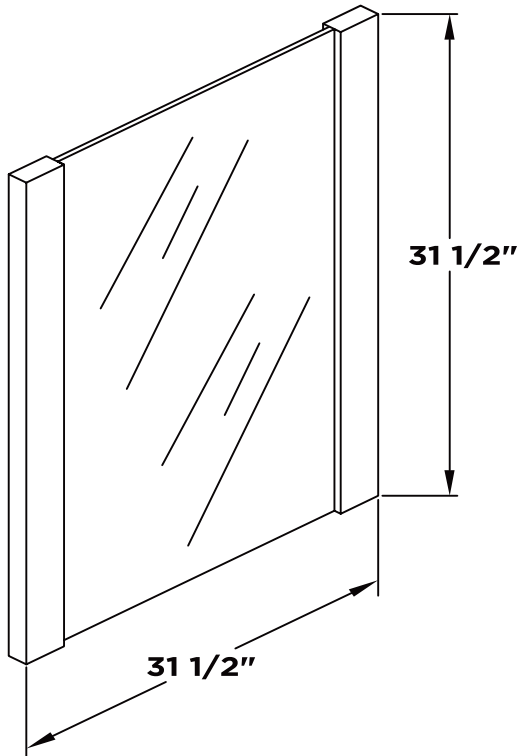

Vanity Front 2PCS

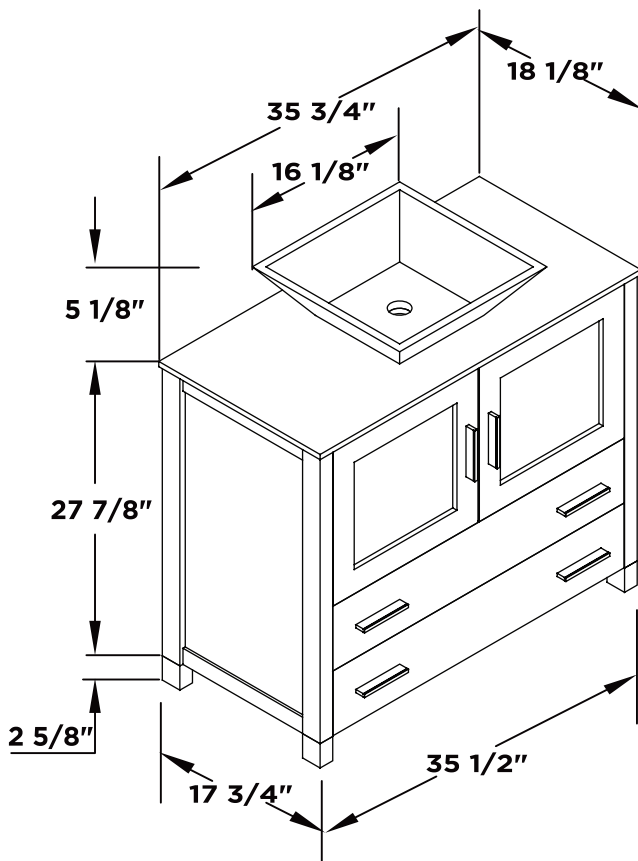

Vanity Back 2PCS

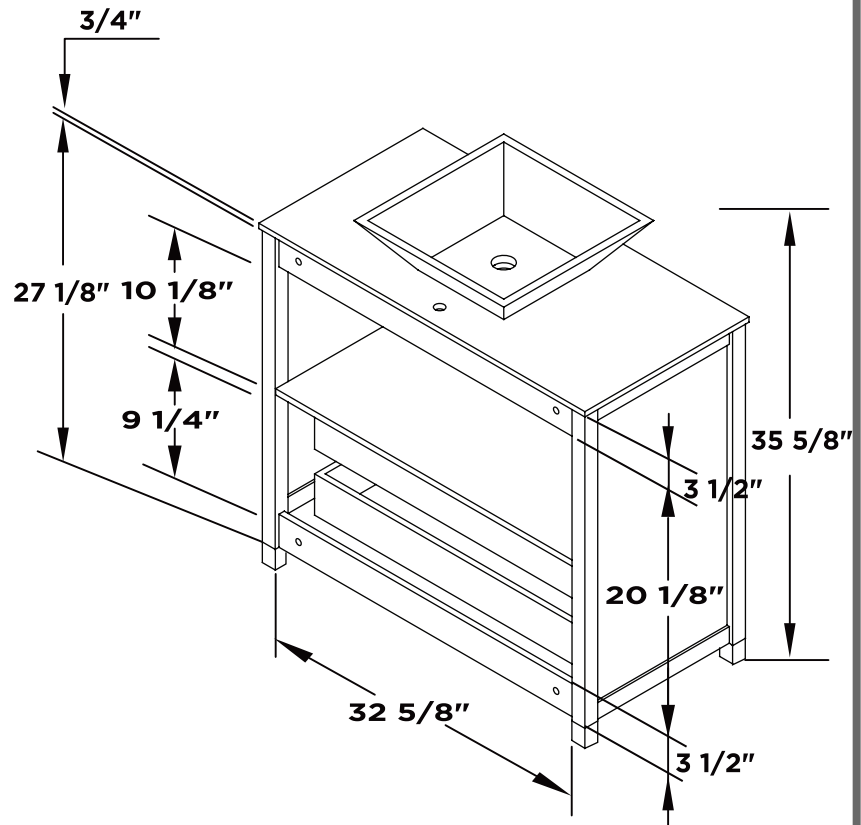

TOOLS FOR ASSEMBLY

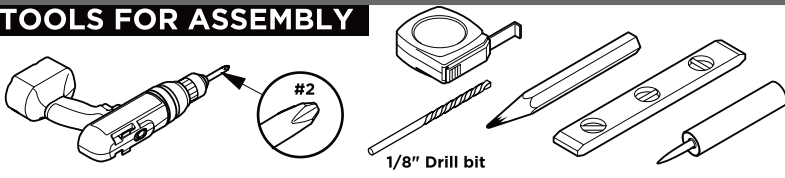

Side Cabinet Front

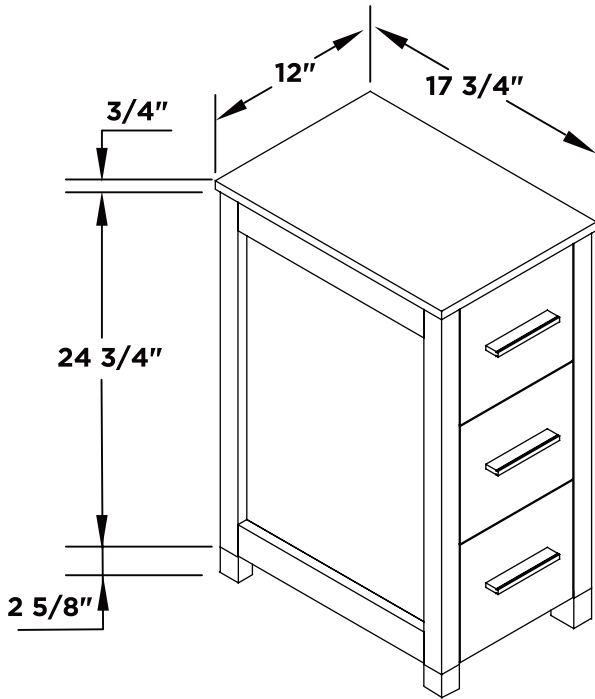

Side Cabinet Back

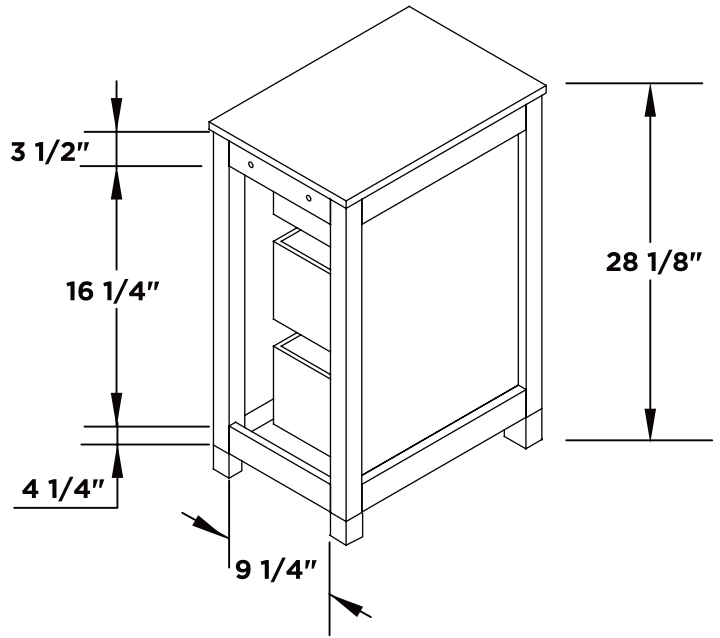

MIRROR INSTALLATION

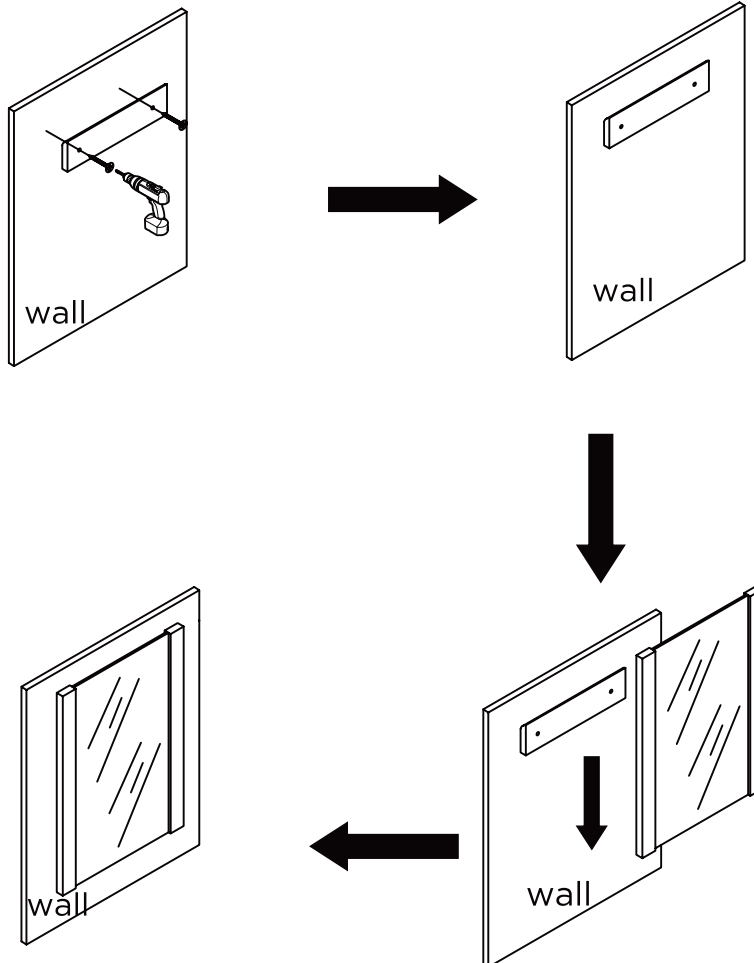

DRAWER REMOVAL & INSTALLATION

REMOVAL

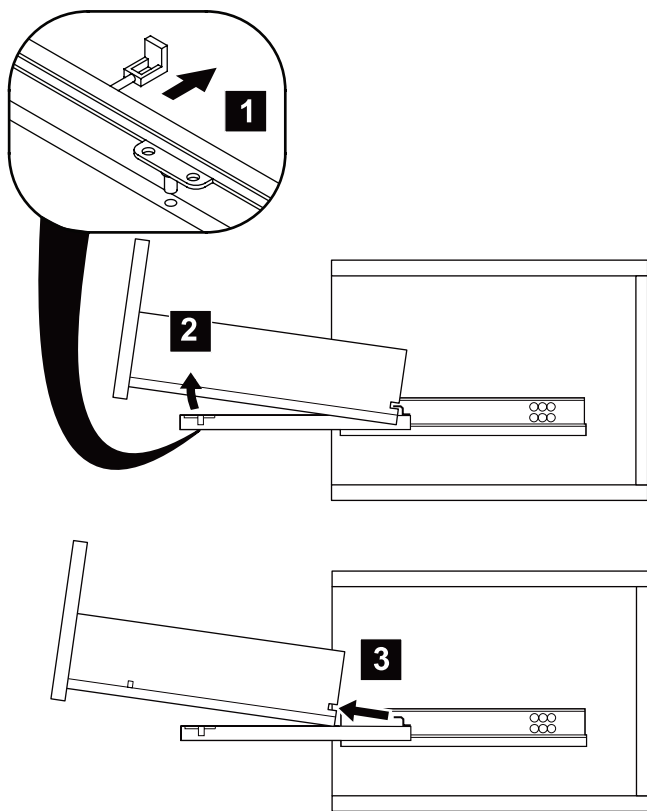

INSTALLATION

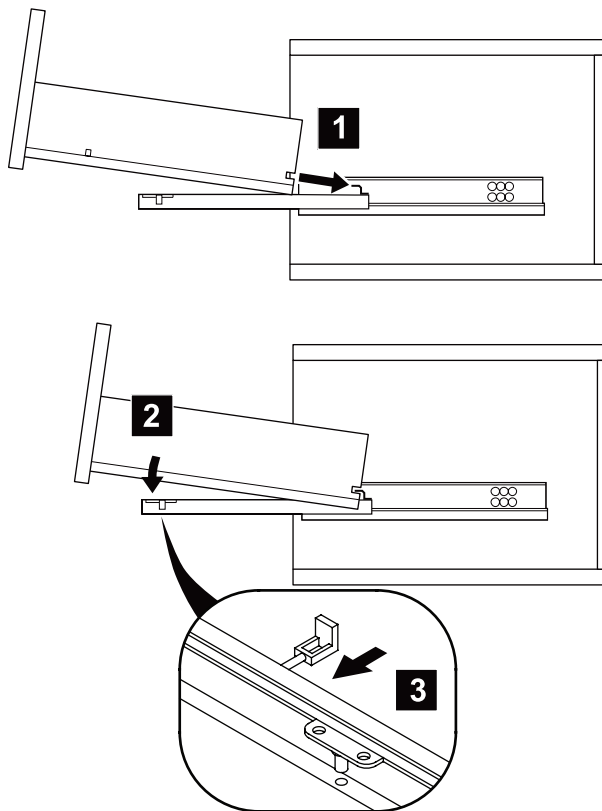

1 Install leg

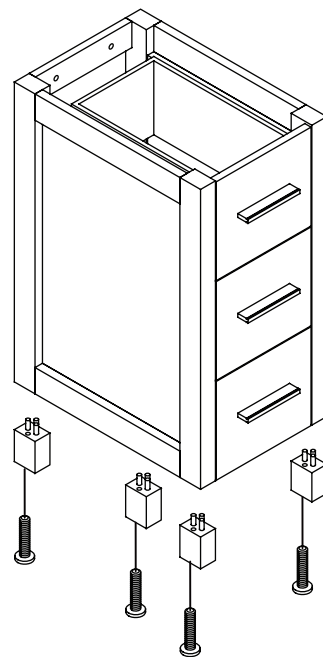
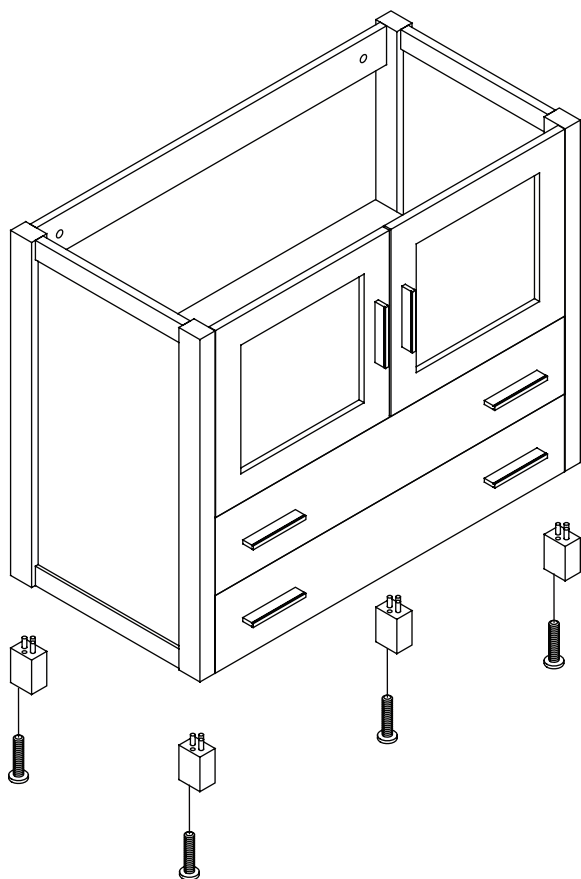

2 Remove drawer

3 Install cabinet

IMPORTANT: Consult an expert for the proper screws/bolts to use when attaching to various wall constructions. Screws provided do not attach to all wall construction types.

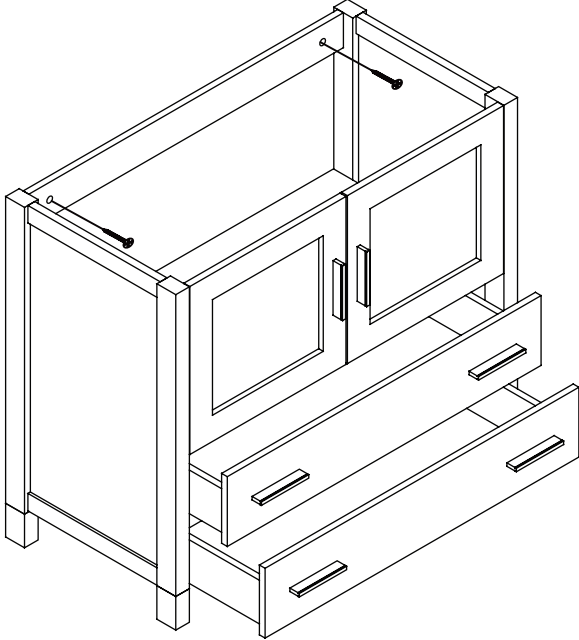

4 Install top panel

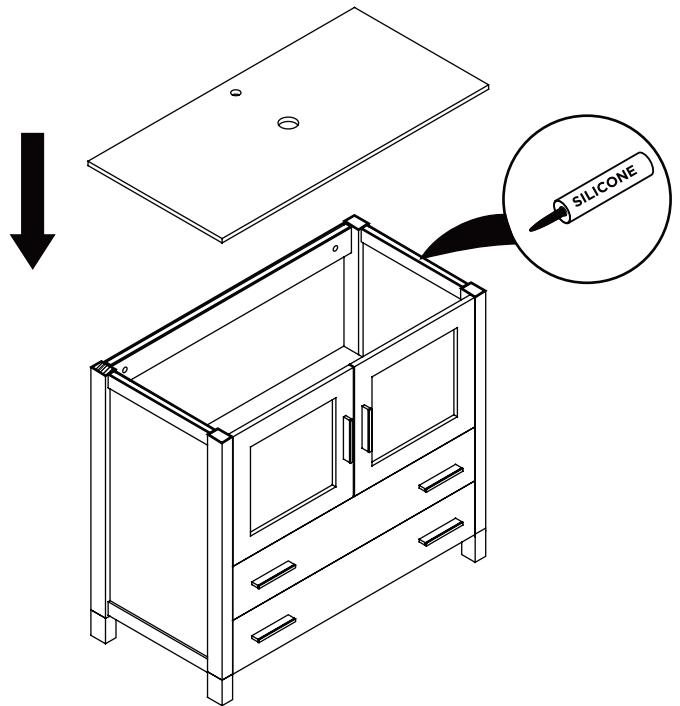

5 Install sink

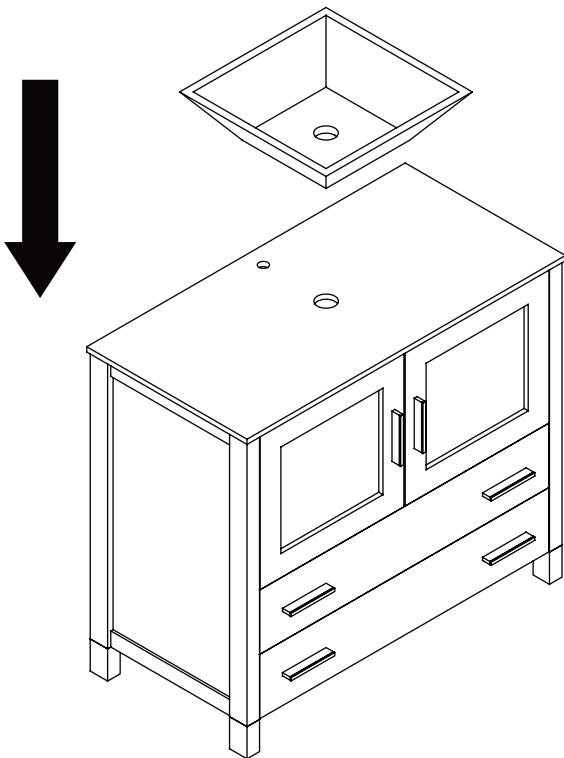

6 Remove side cabinet drawer

7 Install side cabinet

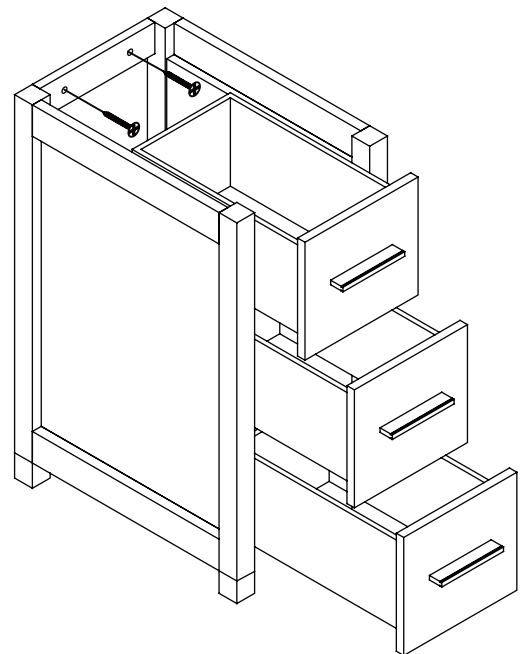

8

Install side cabinet top panel

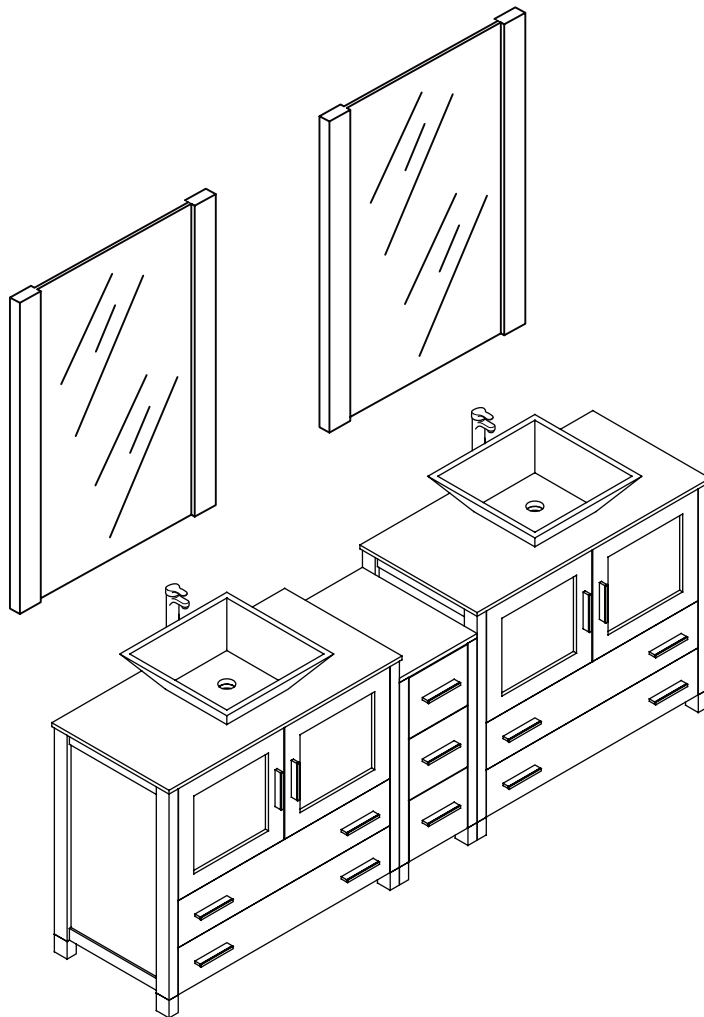
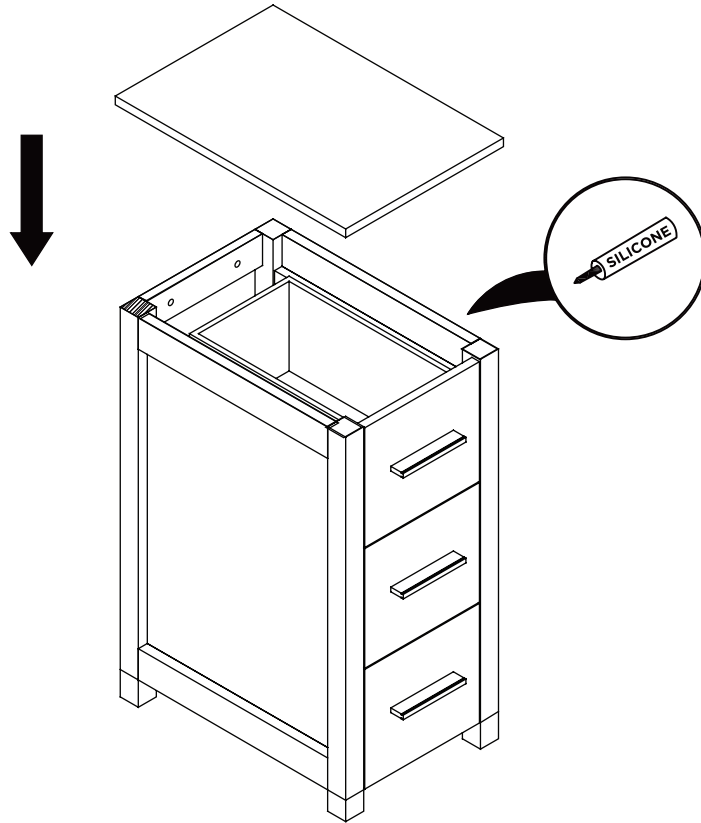

P-TRAP & POP-UP

INSTALLATION INSTRUCTIONS

Your item may appear slightly different from the illustration.

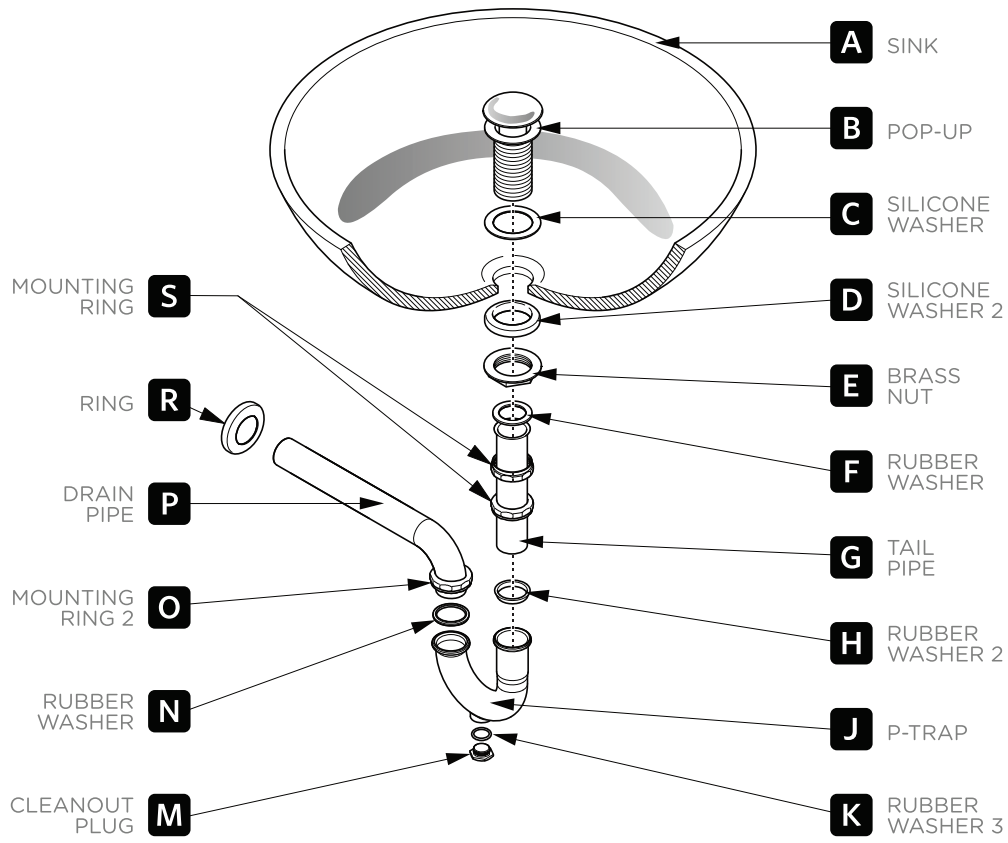

POP-UP INSTALLATION

FOR SINKS WITHOUT OVERFLOW

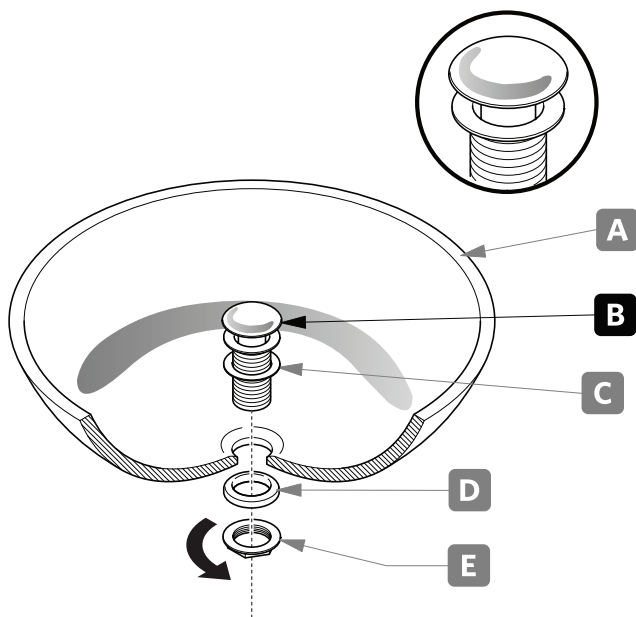

OR

FOR SINKS WITH OVERFLOW

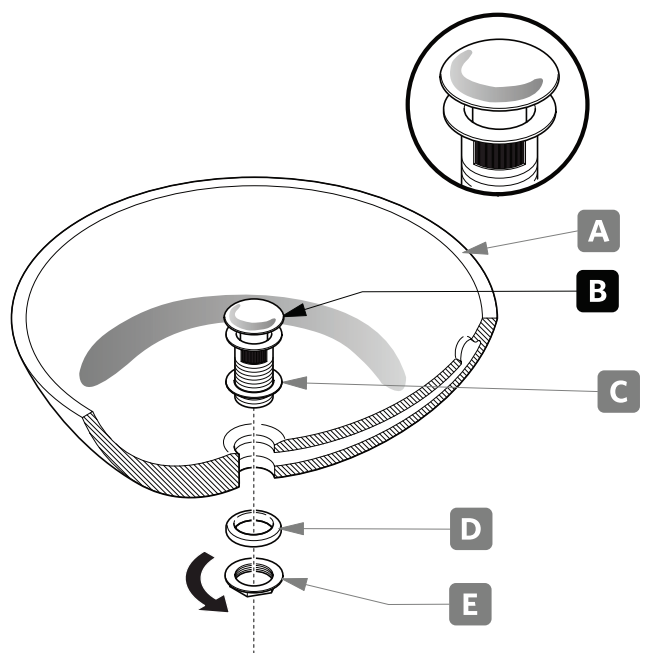

P-TRAP INSTALLATION

1. Install tail pipe (**G**).

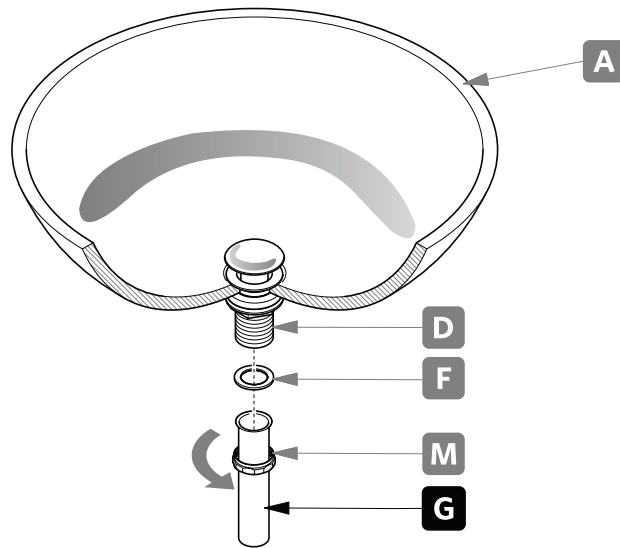

2. Install P-trap (**J**).

