



FVN8330

VALENCIA

INSTALLATION GUIDE

CONTENTS:

Cabinet.....	(FCB8330).....	PAGE 4
Sink.....	(FVS8007WH).....	PAGE 4
Medicine Cabinet.....	(FMC8058).....	PAGE 3

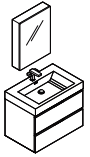

FVN8330 VALENCIA INSTALLATION GUIDE

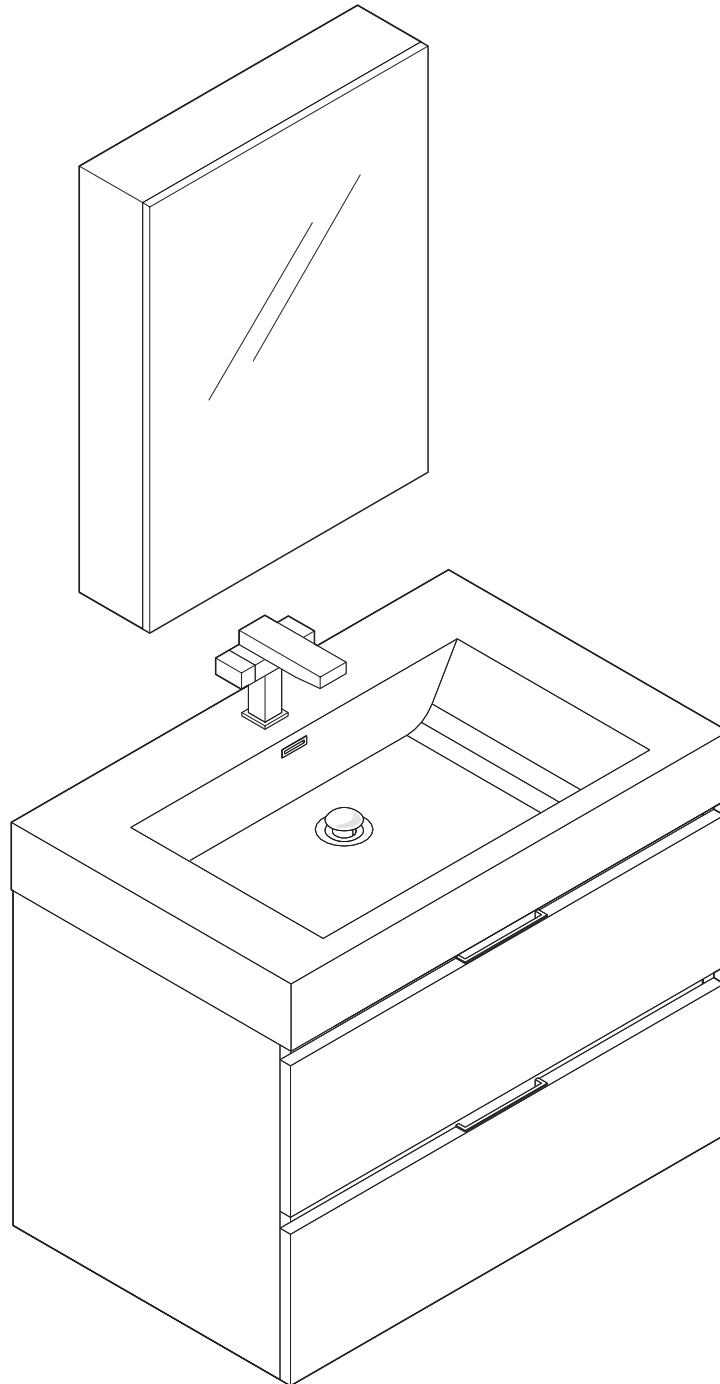

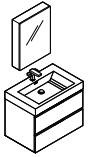

FVN8330 VALENCIA INSTALLATION GUIDE



DIMENSIONS

Sink
TOP VIEW

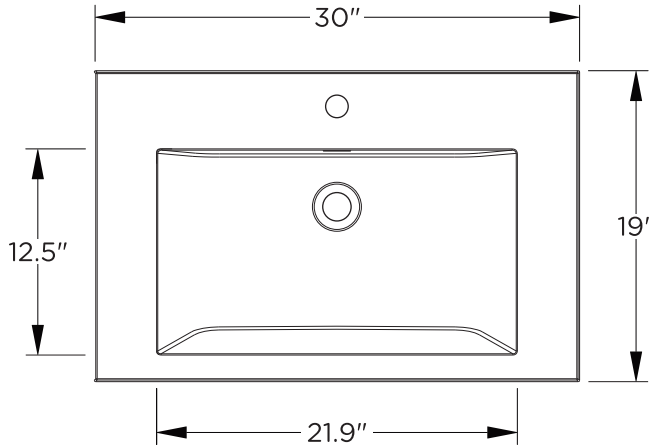

Medicine Cabinet
FRONT VIEW

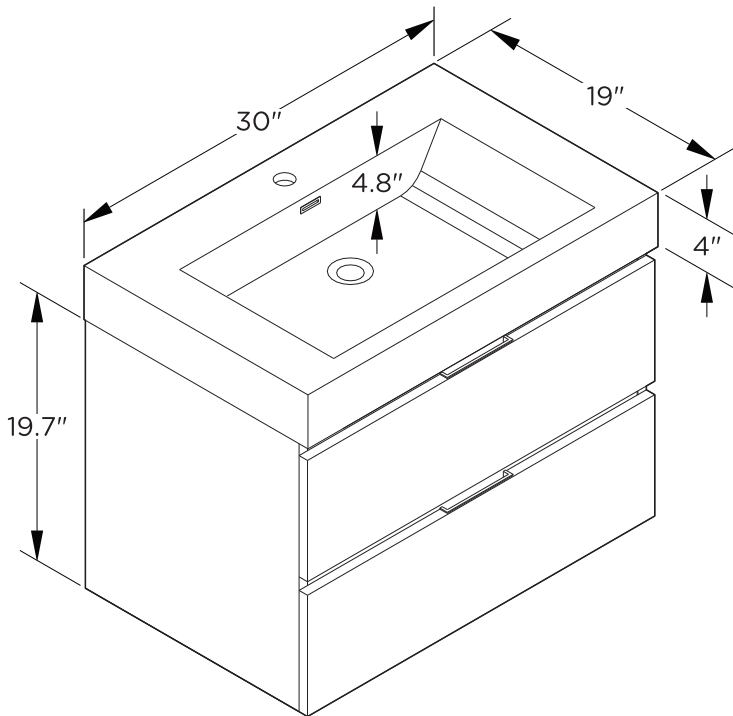
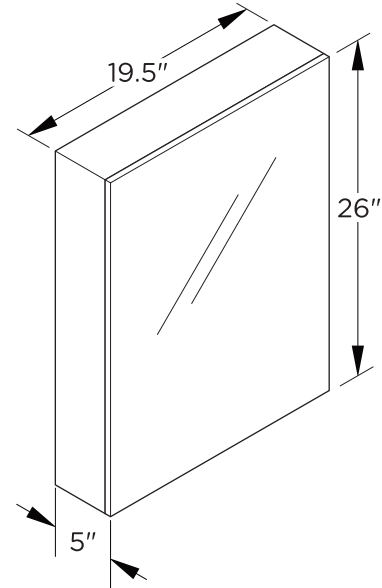

Cabinet
FRONT VIEW

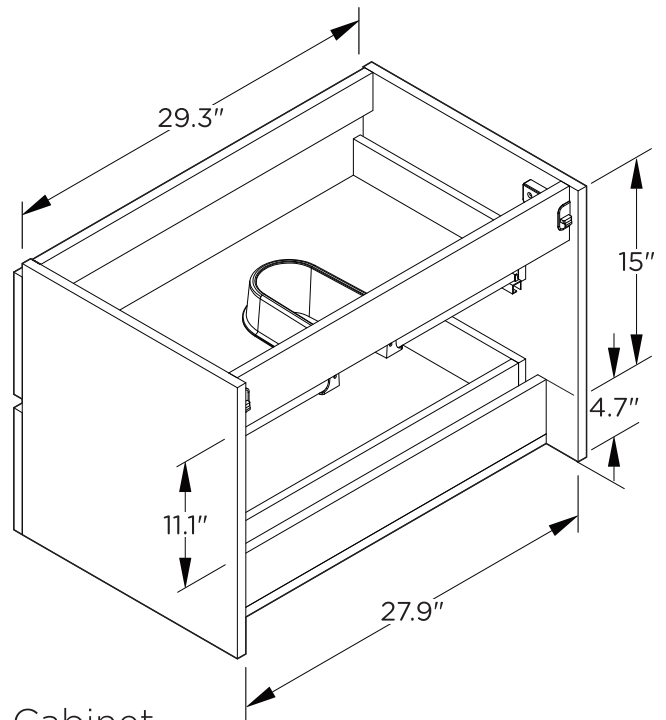

Cabinet
BACK VIEW

NOTE: ALL DIMENSIONS & SPECIFICATIONS ARE APPROXIMATE AND SUBJECT TO CHANGE WITHOUT NOTICE.

MEDICINE CABINET INSTALLATION

1 Attach side mirrors (C) to the medicine cabinet (A).

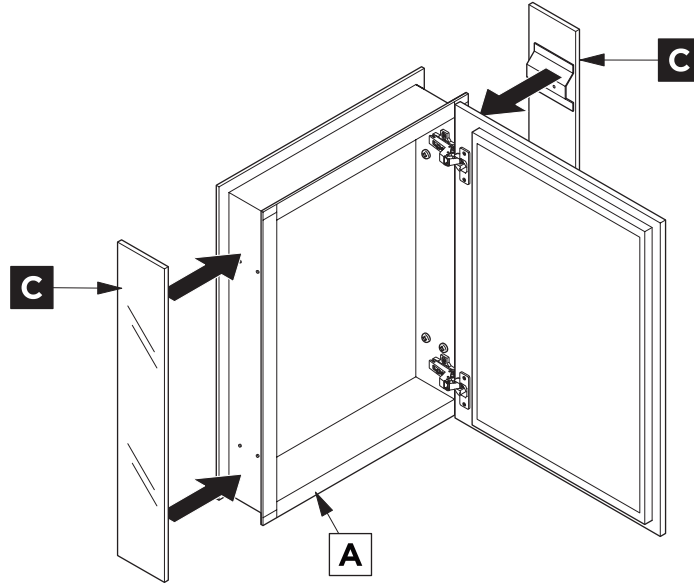

2 Mark cabinet's (A) location.

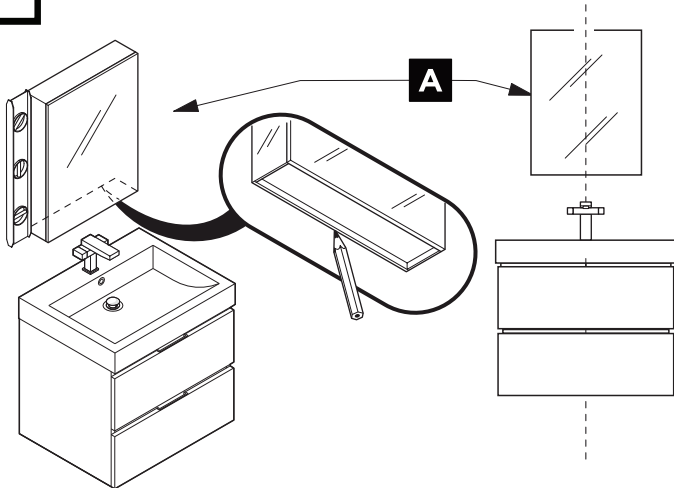

3 Install a bottom bracket (K).

IMPORTANT: Consult an expert for the proper screws/bolts to use when attaching to various constructions. Screws provided do not attach to all wall construction types. Anchors are not required if brackets are installed in stud.

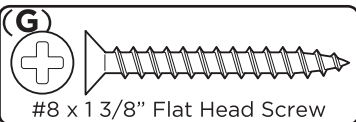
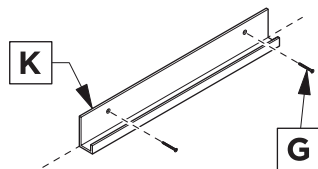

4 * Place cabinet (A) on the bottom bracket (K) and secure it with a top bracket (L).

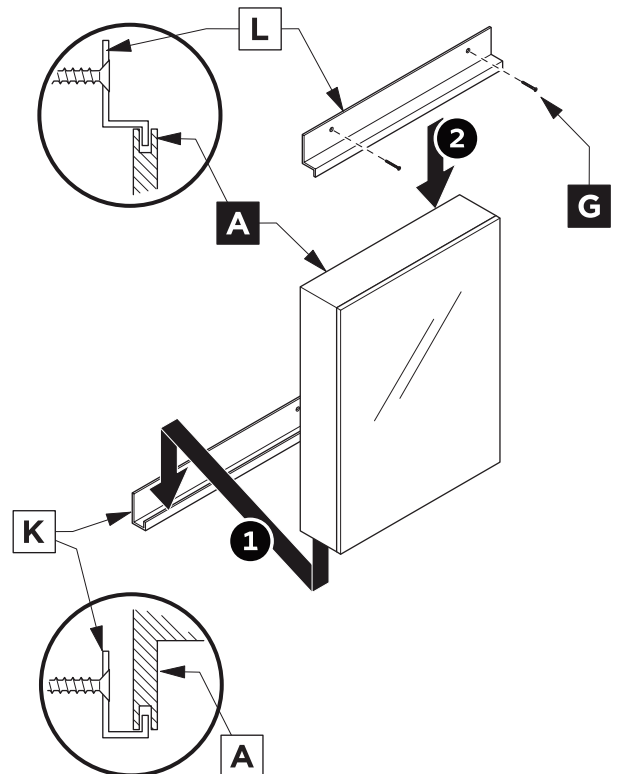

* This step requires assistance to hold cabinet in place until top bracket is securely attached.

CABINET INSTALLATION

1 Mark cabinet's (F) location on the wall.

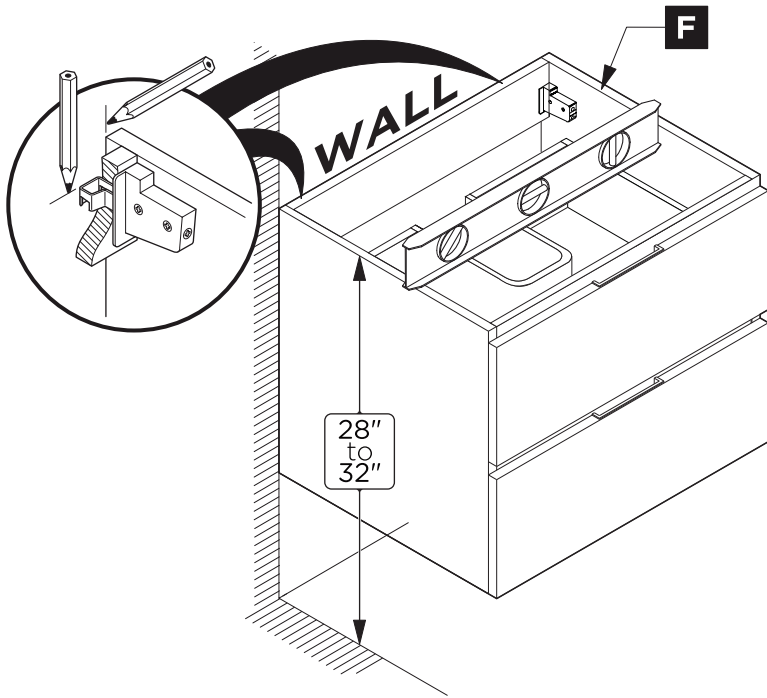

2 Attach wall brackets (J) to the wall.

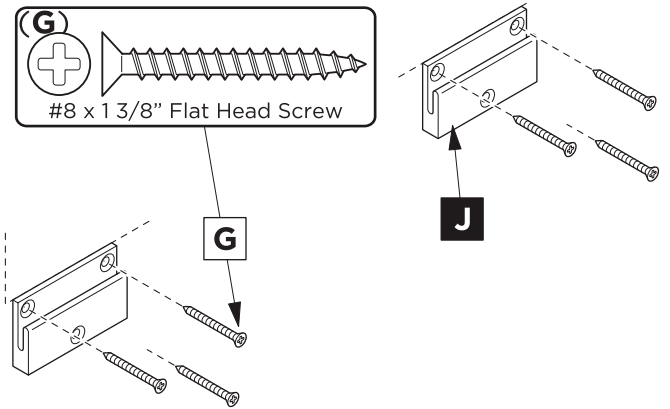

IMPORTANT: Consult an expert for the proper screws/bolts to use when attaching to various constructions. Screws provided do not attach to all wall construction types. Anchors are not required if brackets are installed in stud.

3 Apply a bead of silicone on the back of the cabinet (F). Hang a cabinet (F) on the brackets (J) and secure it with a screwdriver.

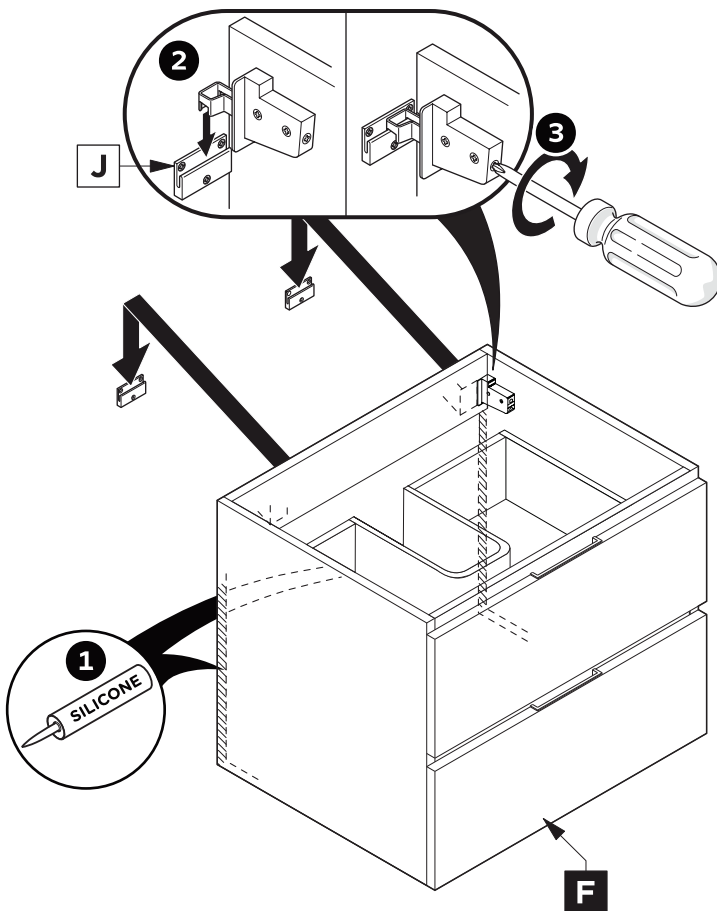

4 Apply a bead of silicone on the top of the cabinet (F) and place sink (E) on it. Apply silicone on the bottom of the cabinet (F) and place the sink (E) on it.

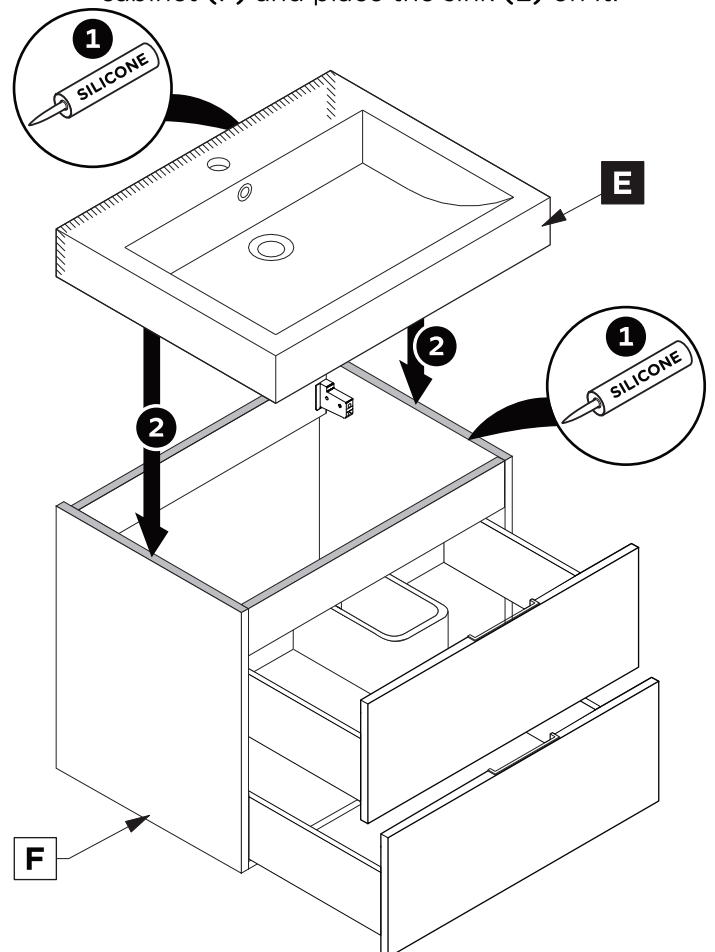

DRAWER REMOVAL

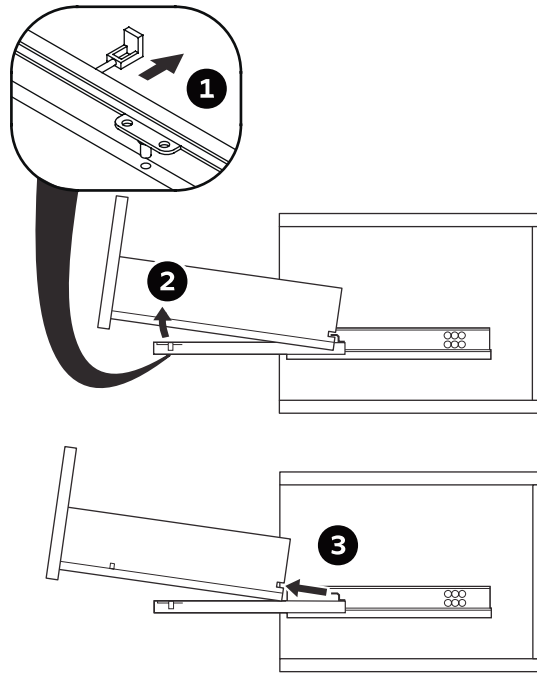

DRAWER INSTALLATION

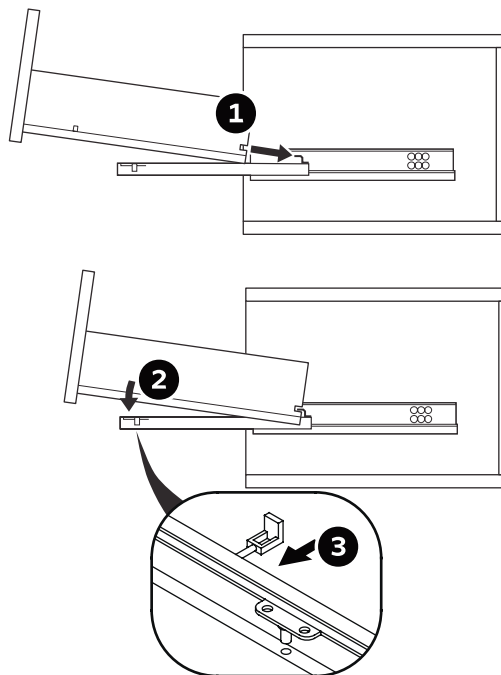

P-TRAP & POP-UP INSTALLATION INSTRUCTIONS

Your item may appear slightly different from the illustration.

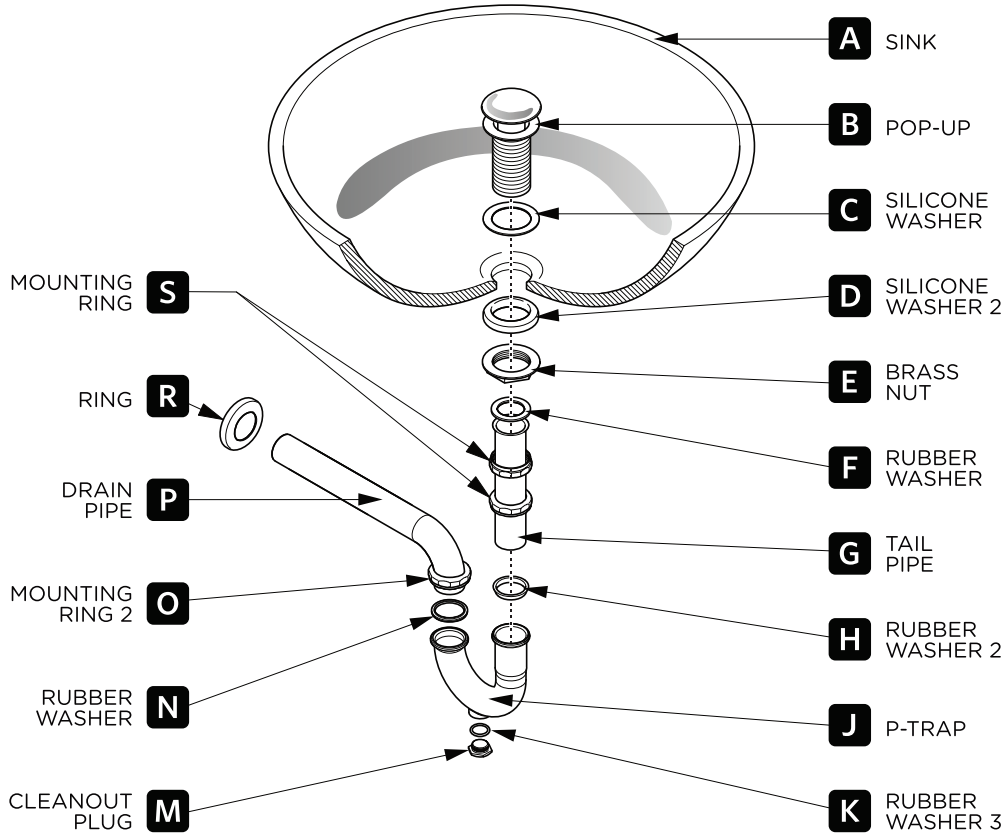

POP-UP INSTALLATION INSTRUCTIONS

FOR SINKS WITHOUT OVERFLOW

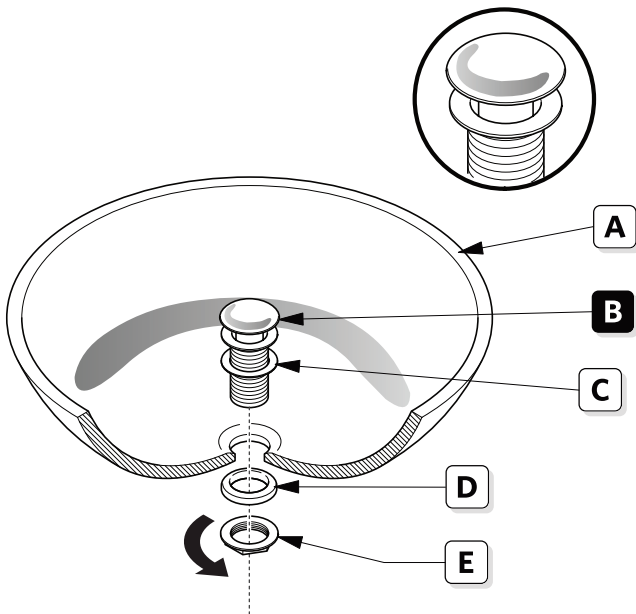

OR

FOR SINKS WITH OVERFLOW

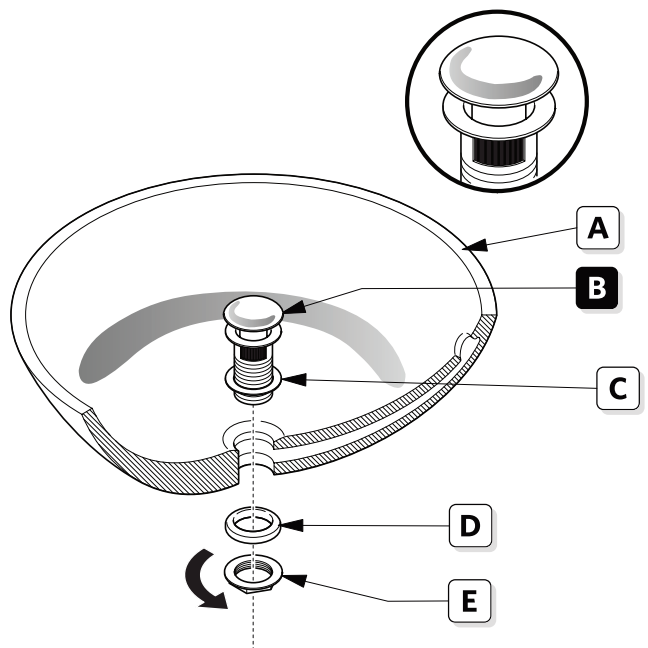

P-TRAP INSTALLATION

1 Install Tail Pipe (G).

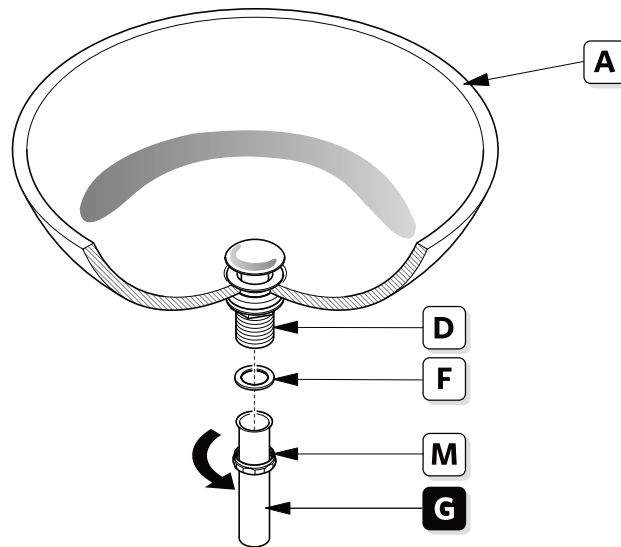

2 Install P-Trap (J).

